



SERVICE BULLETIN

Classification: EC07-005a	Reference: NTB07-060a	Date: September 2, 2008
------------------------------	--------------------------	----------------------------

2005 – 2007 PATHFINDER; MIL “ON” WITH DTC P0442 / P0448 / P0455 / P0456 / P1446

This bulletin has been amended to add P0448. No other changes have been made.

APPLIED VEHICLES: 2005 – 2007 Pathfinder (R51)

IF YOU CONFIRM:

A MIL “ON” with one or more of the following DTC(s) stored:

- P0442 / P0448 / P0455 / P0456 / P1446

AND

- EVAP Vent Control S/V is stuck open or will not seal when operated/closed.

ACTIONS:

1. Replace the EVAP Vent Control S/V.
2. Install the Filter Kit (refer to the Service Procedure in this bulletin).
3. Clear any DTCs stored in the ECM.

IMPORTANT: The purpose of "ACTIONS" (above) is to give you a quick idea of the work you will be performing. You **MUST** closely follow the entire Service Procedure (starting on page 3) as it contains information that is essential to successfully completing this repair.

Nissan Bulletins are intended for use by qualified technicians, not 'do-it-yourselfers'. Qualified technicians are properly trained individuals who have the equipment, tools, safety instruction, and know-how to do a job properly and safely. NOTE: If you believe that a described condition may apply to a particular vehicle, DO NOT assume that it does. See your Nissan dealer to determine if this applies to your vehicle.

PARTS INFORMATION

DESCRIPTION	PART NUMBER	QUANTITY
EVAP Vent Control S/V	14935 – AM60A	1
Filter Kit	14953 – ZP80C	1
Bitumen Wax	999MP-9G001P (1) (shop supply)	as needed
Zinc-Rich Primer	Local Source (2) (shop supply)	as needed

(1) Bitumen Wax is available from the Nissan Direct Ship Chemical Care Product Program: Phone 1-800-811-0502, Fax 1-770-218-0148, Website order link via dealer portal www.NNAnet.com or direct www.NissanChemicals.com

(2) Use one of the following Zinc Rich primers or an equivalent:

- 3M™ Zinc Spray 16-501

For help finding a local source for 3M™ products or obtaining an MSDS, contact 3M™ Automotive Aftermarket Division at 1-877-MMM-CARS.

- CRC® Zinc-It® 18412

For help finding a local source for CRC® products or obtaining an MSDS, contact CRC® Customer Service Representative at 1-800-272-8963.

CLAIMS INFORMATION

Submit a Primary Part (PP) type line claim using the following claims coding:

DESCRIPTION	PFP	OP CODE	SYM	DIA	FRT
Replace EVAP Vent Control Valve	(3)	FC50AA	HD	32	(4)

(3) Reference the Parts Information Table and use the EVAP Vent Control S/V P/N as the PFP.

(4) Reference the current Nissan Warranty Flat Rate Manual and use the indicated FRT.

AND, on the same line, use Combination Op Code:

DESCRIPTION	OP CODE	FRT
Install filter kit	FX30AA	0.4

NOTE: Do NOT submit a claim for the Bitumen Wax or the Zinc Rich primer as these are considered shop supplies.

SERVICE PROCEDURE

Replace Vent Control Valve

1. Replace the EVAP Vent Control S/V.
 - Refer to section EC in the Service Manual for replacement information.

Install Filter Kit

1. Remove the spare tire.
2. Remove the EVAP canister mounting bolt (see Figure 1).
 - The canister will drop about 3 inches which will give you working room at the top.
3. Disconnect the vent hose (see Figure 1).

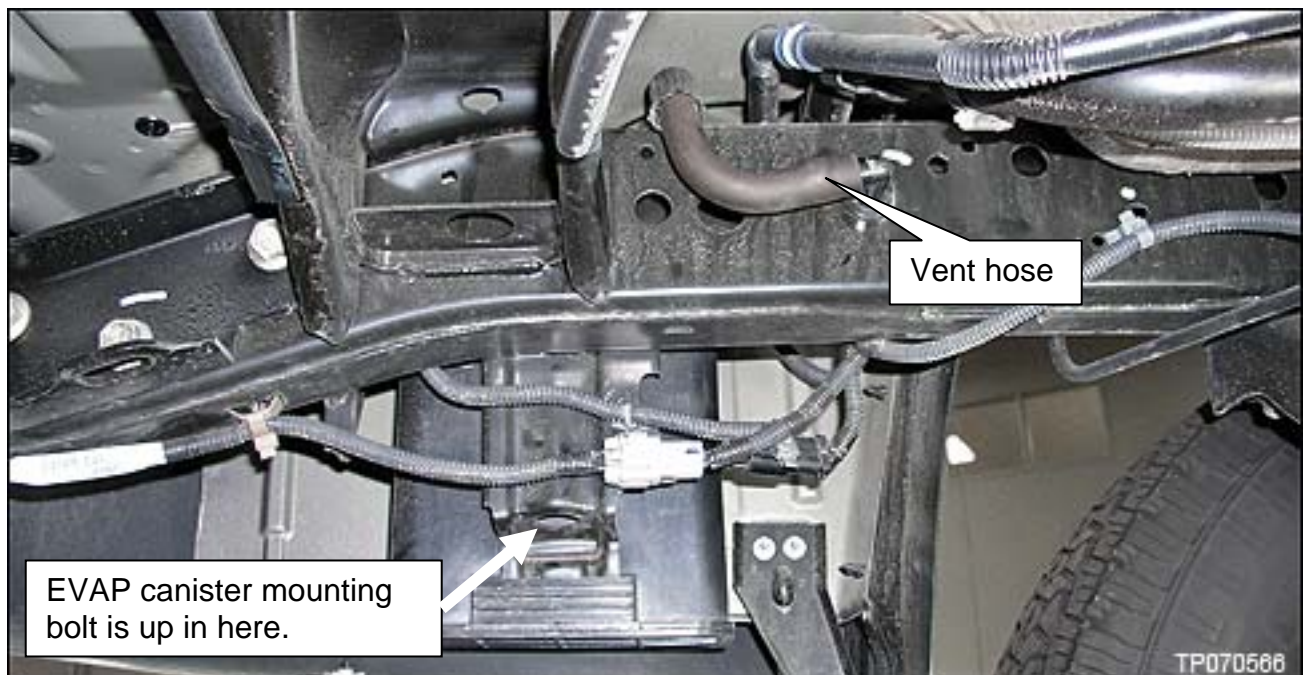

Figure 1

4. Reach above the EVAP canister and disconnect the vent hose at the vent control valve and remove the hose (see Figure 2).
 - Twisting the hose at the opposite end will help loosen it at the vent control valve.
5. Remove the vent hose connector; pull it straight out (see Figure 2).



Figure 2

6. Install the new vent hose connector—included in the filter kit (see Figure 3).



Figure 3

7. Cut out the template on page 10 and place it on the frame rail as shown in Figure 4.
 - Make sure the template is aligned (straight) with the frame rail.
8. Center punch and drill at the locations shown in Figure 4:
 - Upper location: Drill a 13/32 (10 mm) hole.
 - Lower location: Drill a 5/16 (8 mm) hole.

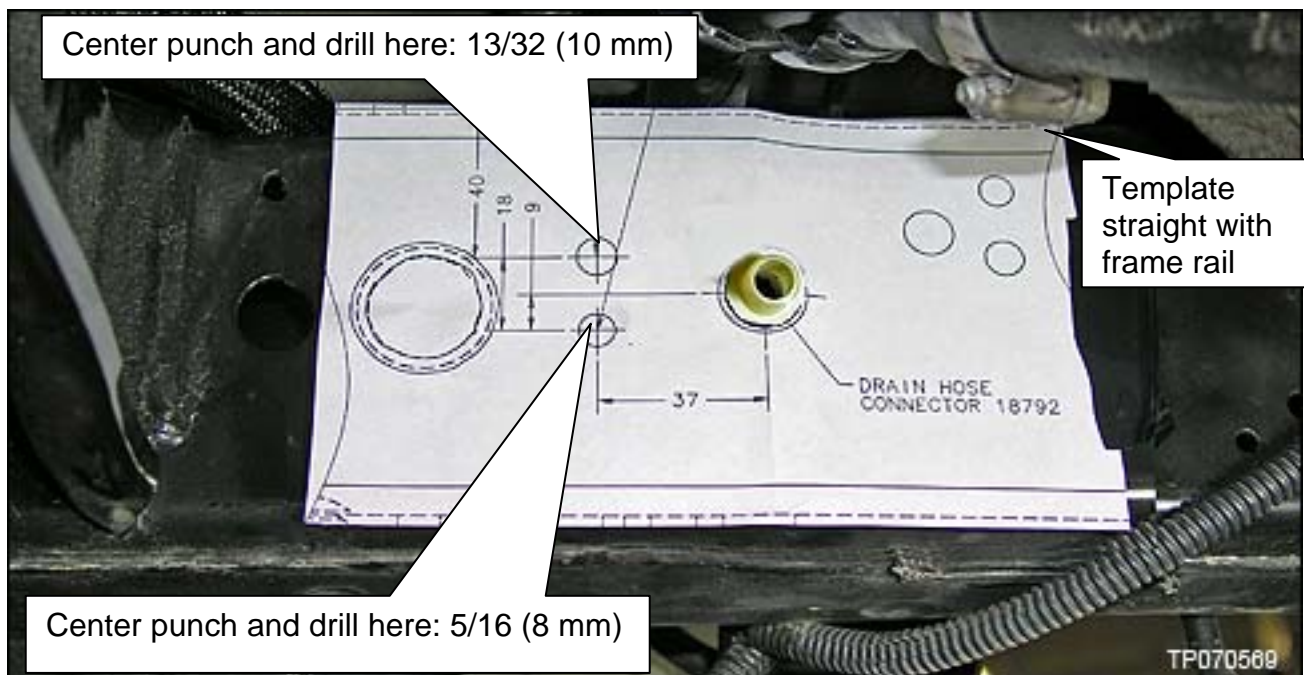

Figure 4

9. Prep the holes you just drilled as follows:
 - a. Remove burs from the edges with a file or sandpaper.
 - b. Clean the holes with solvent and allow to completely dry.
 - c. Apply / cover all bare metal with Zinc Rich primer (see Parts Information for Zinc Rich primer).
 - d. Allow primer to dry—approximately 1 hour.

10. Prepare the bracket for installation as follows:

- a. Assemble the collapsible nut, spacer nut, and bolt as shown in Figure 5.

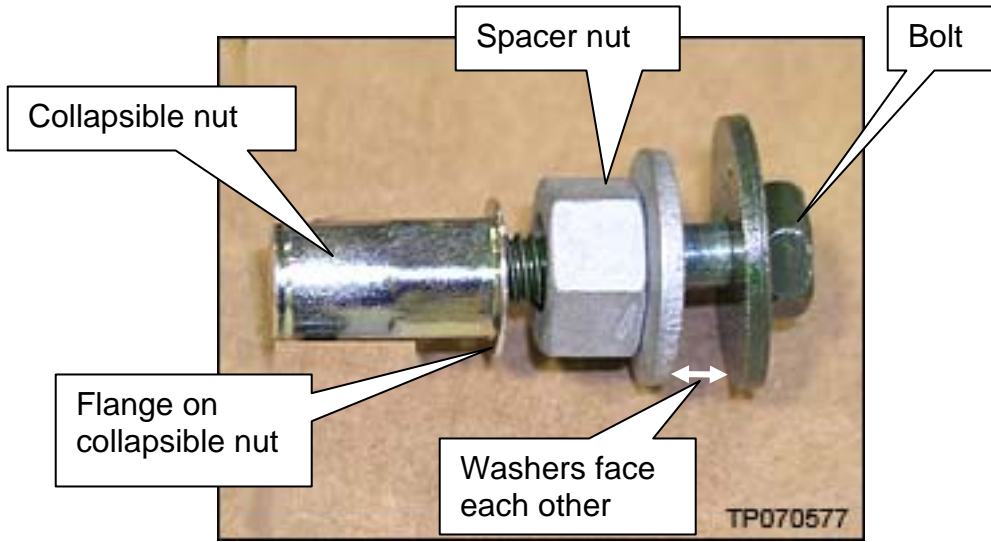

Figure 5

- b. Finger tighten the assembly in Figure 5.
- c. Install / push the nut and bolt assembly into the bracket as shown in Figure 6.

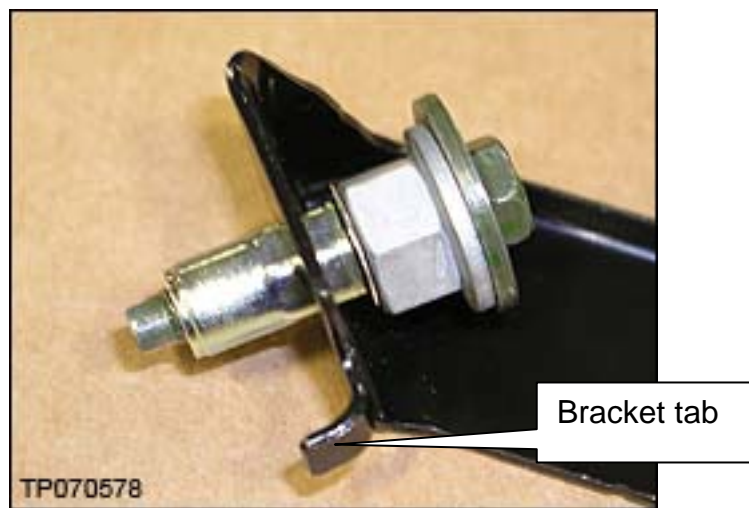

Figure 6

11. Install the bracket on the frame rail (see Figure 7).

NOTE: The collapsible nut will be a tight fit and may require tapping with a hammer to get it all the way in.

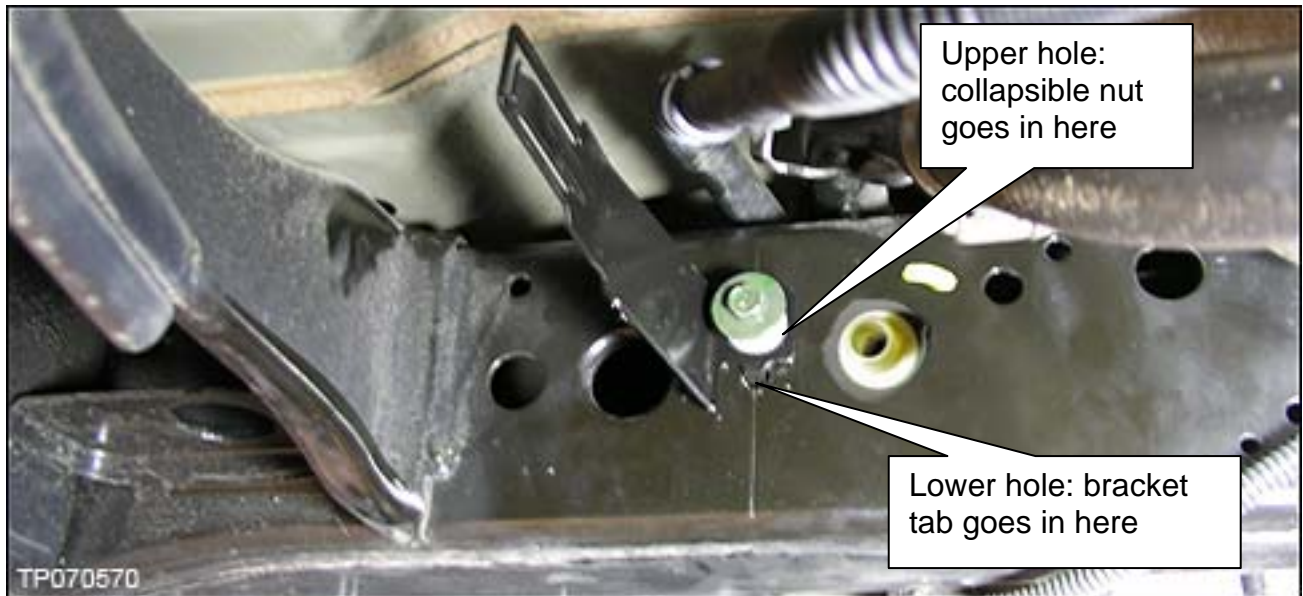

Figure 7

12. Torque the bolt to: 11.0 N•m (1.1 Kg-m, **96 in-lb**)

NOTE: Use a 13mm open end wrench to hold the spacer nut while tightening the bolt.



Figure 8

13. Assemble the hoses onto the filter as shown.

- Pay attention to the position of paint marks on the hose ends (paint marks face UP).

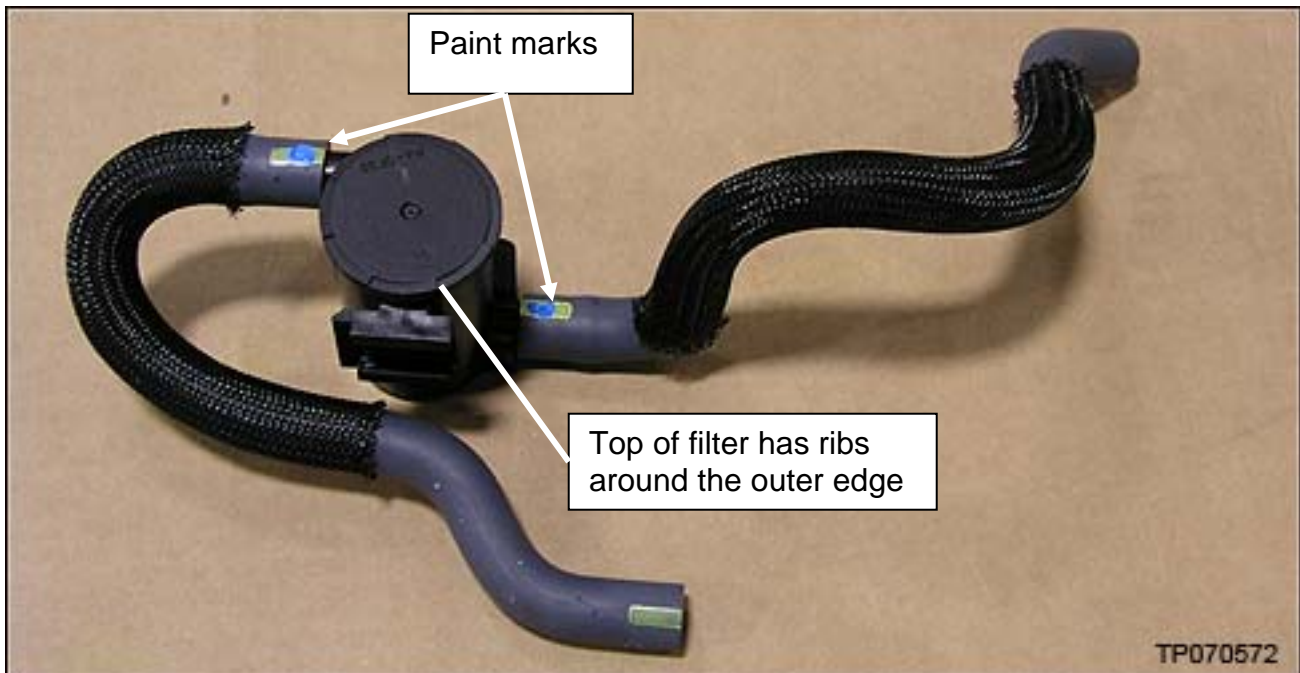

Figure 9

14. Attach the filter to the bracket and connect the hoses as shown in Figure 10.

- Reach above the EVAP canister to connect the vent hose to the vent control valve.

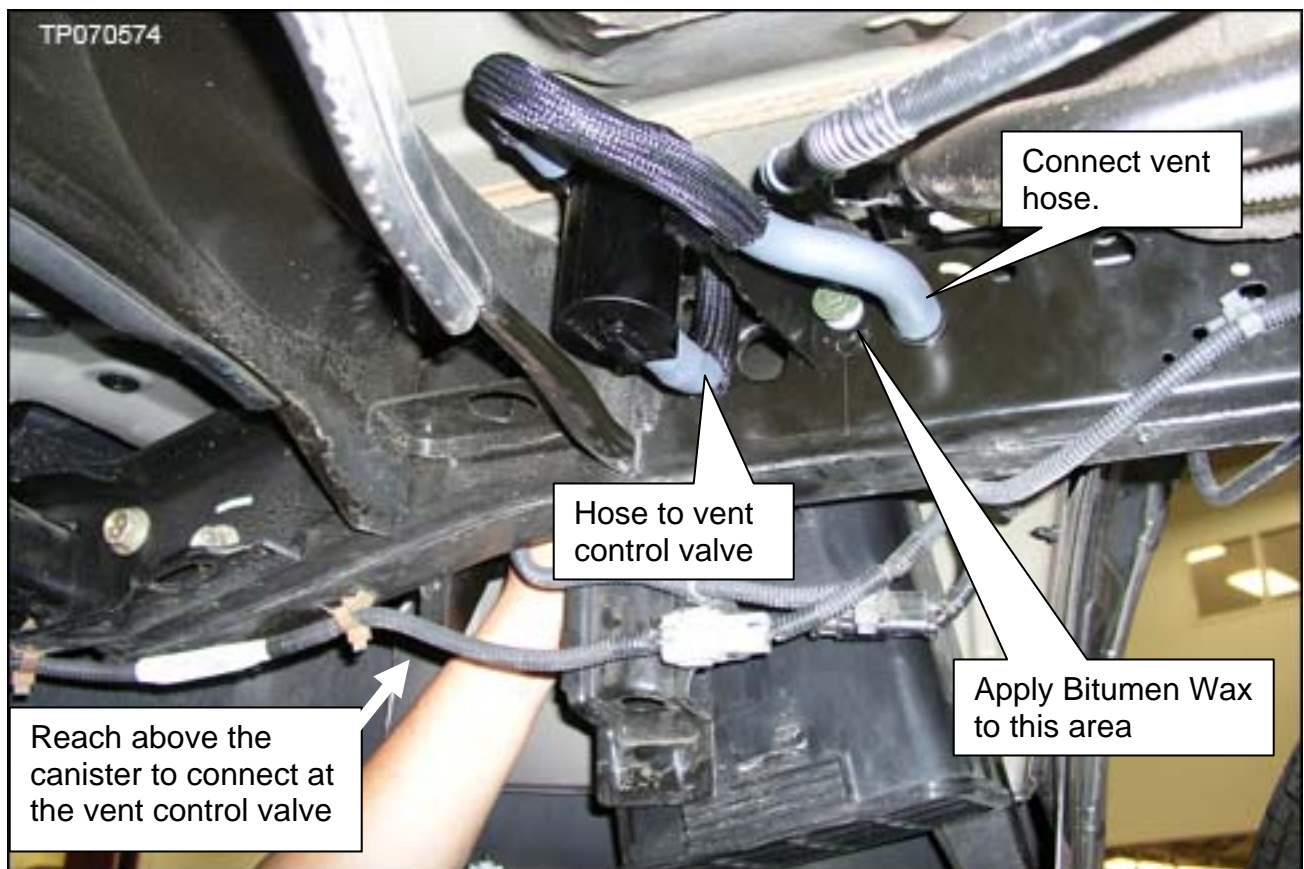

Figure 10

15. Coat / spray the bracket bolt and the frame around the bolt with Nissan Bitumen Wax (P/N 999MP-9G001P).

16. Reinstall the EVAP canister mounting bolt.

17. Clear any DTCs stored in the ECM.

Cut the template on the dashed lines.

Cut out the dashed circle around the drain / vent hose connector.

NOTE: Make sure the template printed to the correct size / scale by checking the 37 mm, 40 mm, and 18 mm dimensions.

